

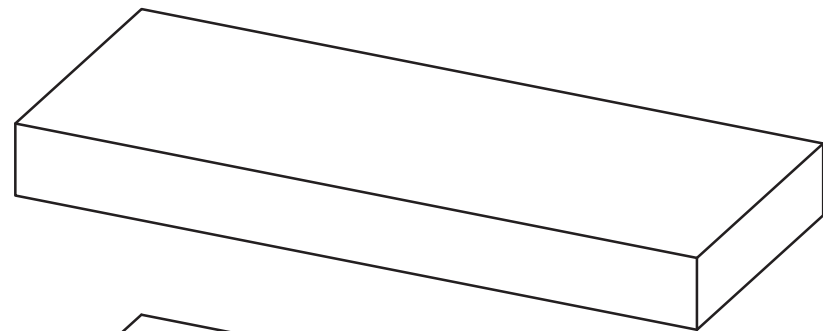

- ① x 8
- ② x 1
- ③ x 4

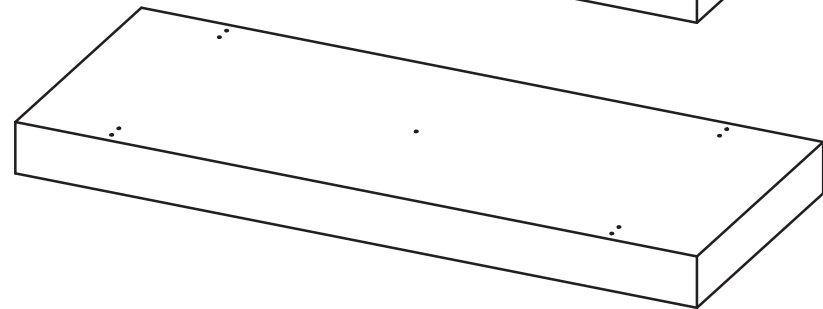

A x 1



B x 1



C x 4



D x 2

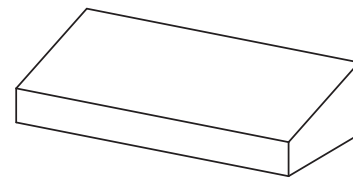

E x 2

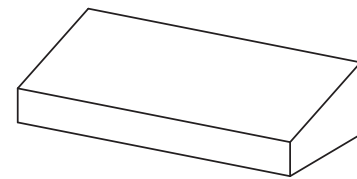

069488

2-A

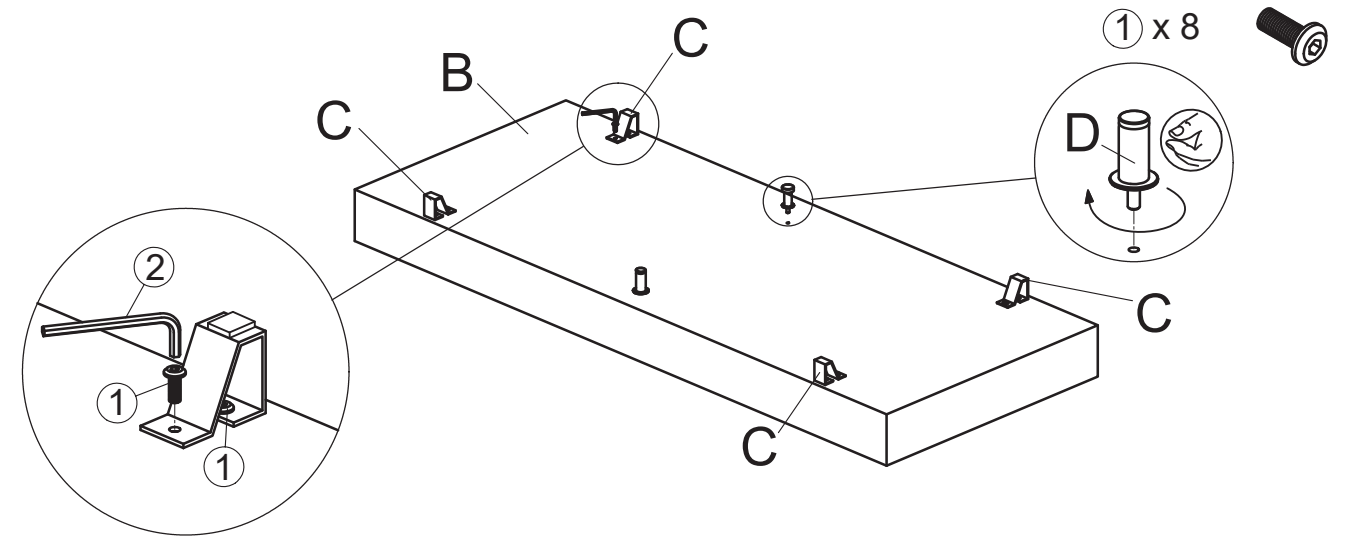

2-B

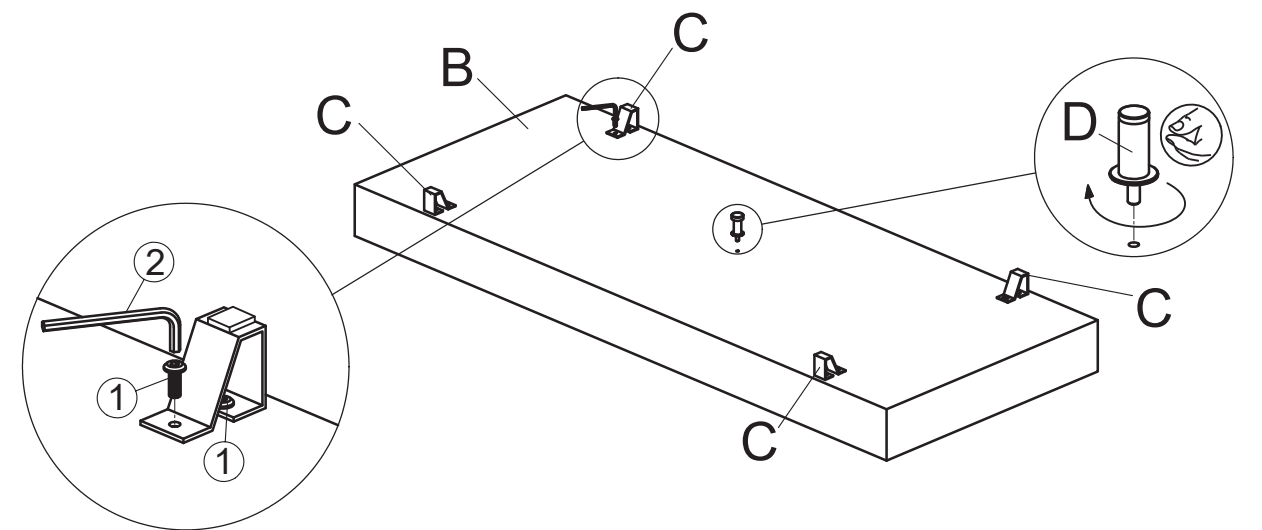

1

③ x 4

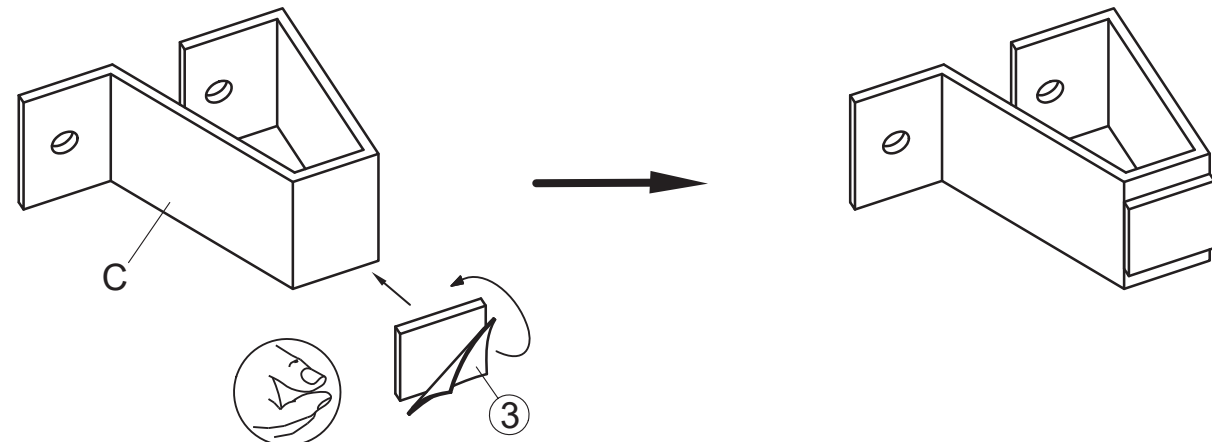

3

