

Monteringsanvisning

Soffbord

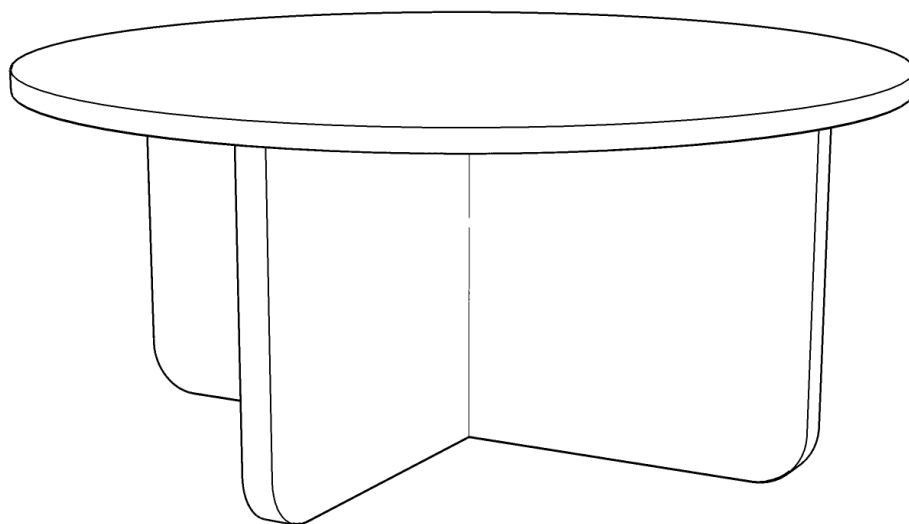

Du behöver



ca 5 minuter

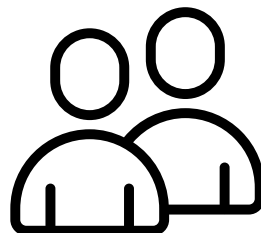

2 personer

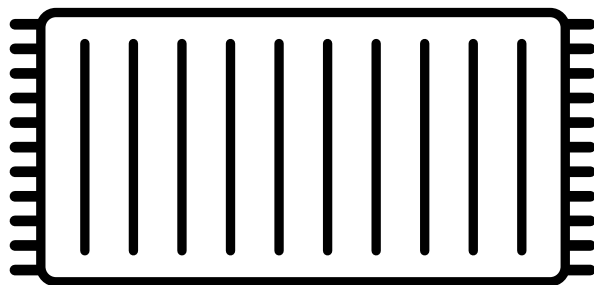

Lägg din produkt på ett mjukt underlag när du monterar

Ingående delar

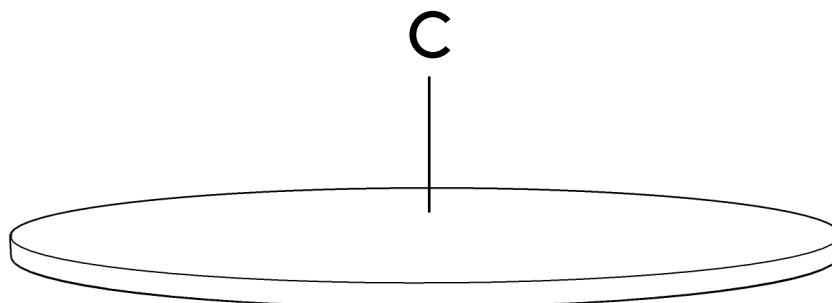
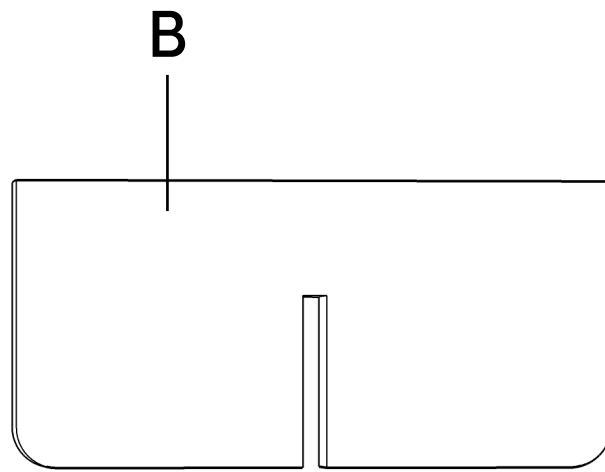
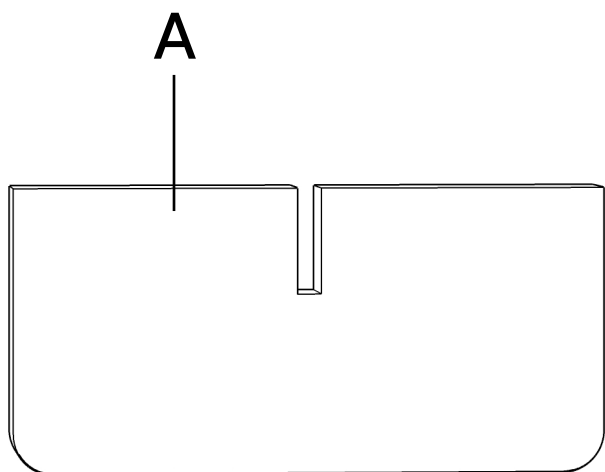

D  X 4 gummitassar

E  X 4 filttassar

Montering

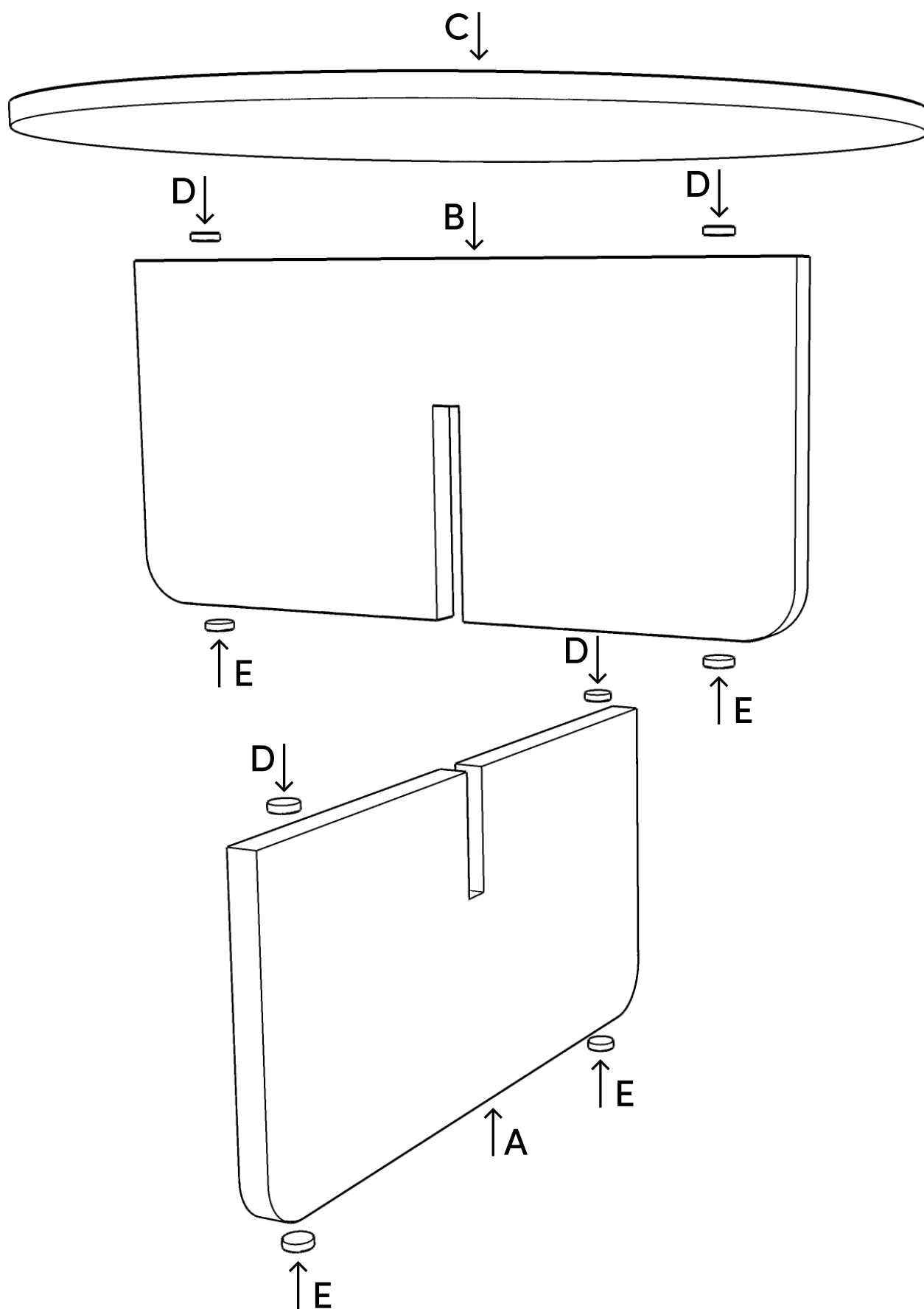

OBS! Skjut inte bordet, lyft vid förflyttning.